

Model	R2AA06020FCPWJ*
Part No.	410627-126*

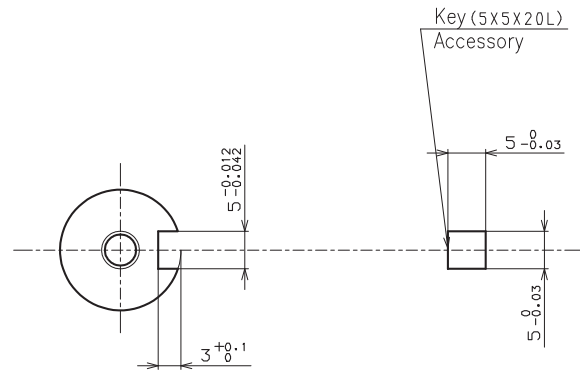

A - A (2 : 1)

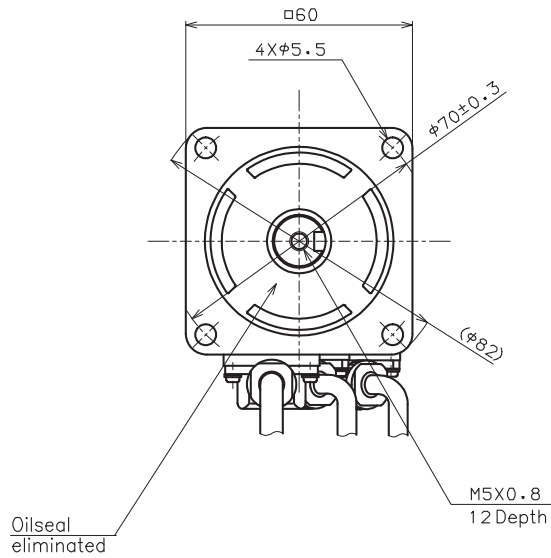