

Model	R2AA06040FCPWJ*
Part No.	410627-128*

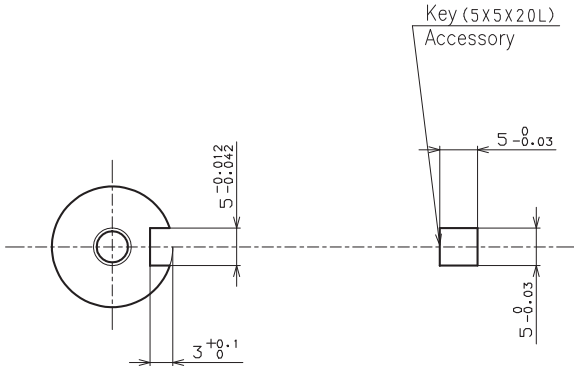

A - A ( 2 : 1 )

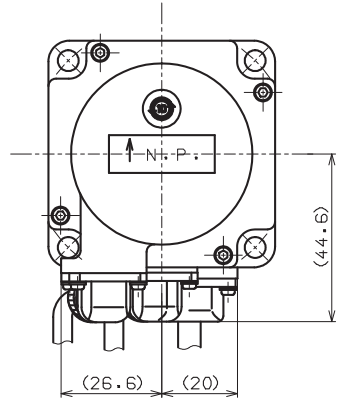
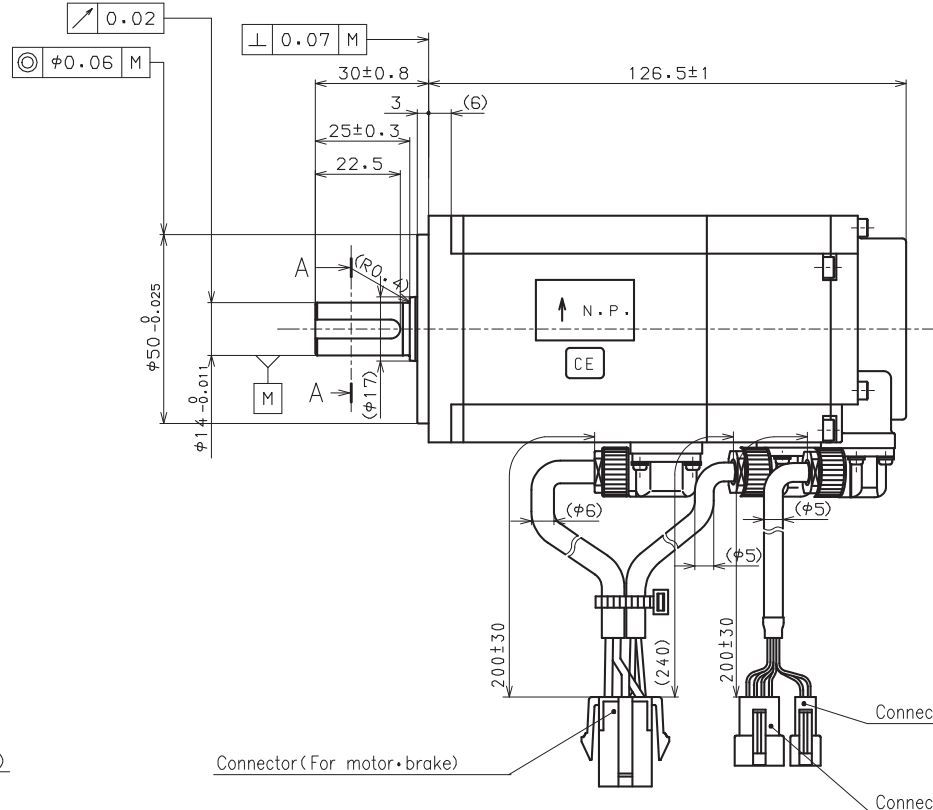
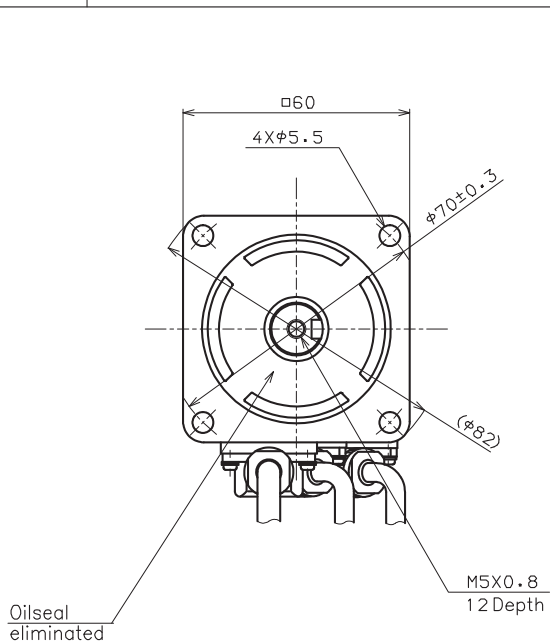