

Model	R2AA04005FXPWL*
Part No.	410627-119*

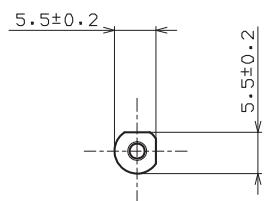

A - A (2 : 1)

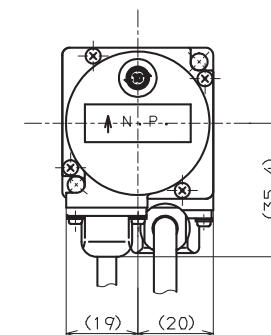
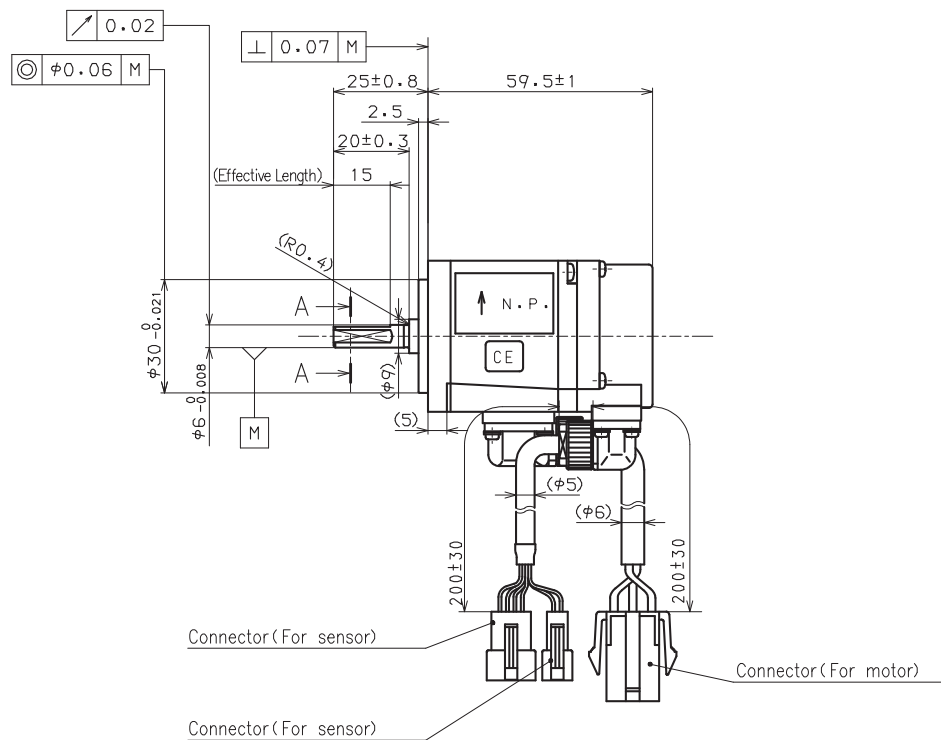
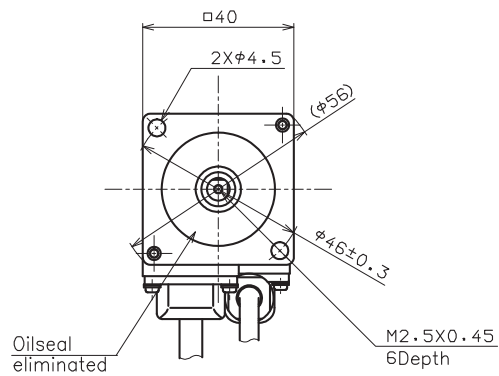