

Model	R2AA04005FCPWL*
Part No.	410627-120*

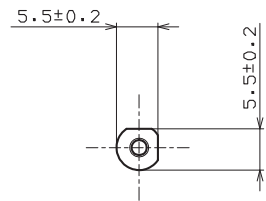

A - A (2 : 1)

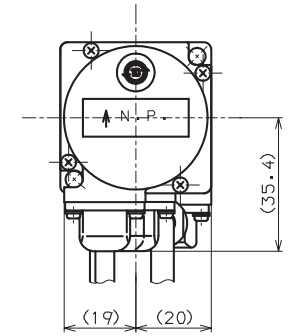
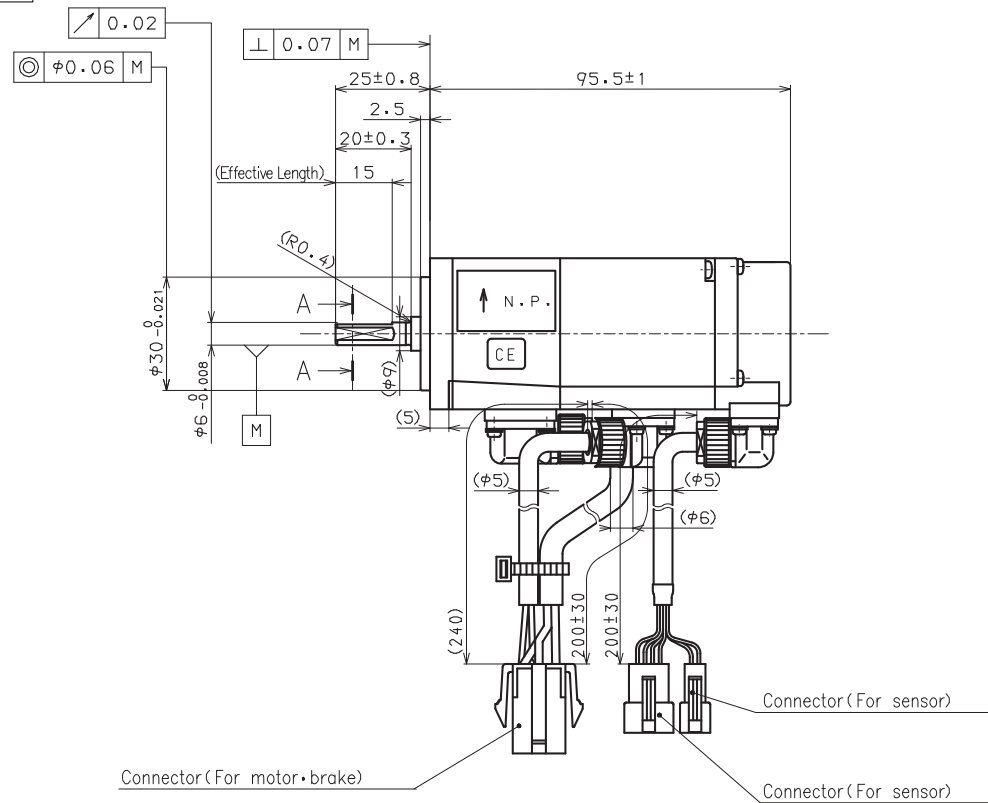
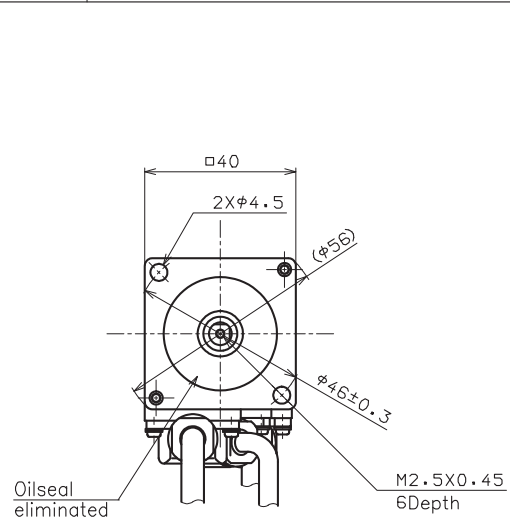