

Model	R2AA04010FCPWJ*
Part No.	410627-122*

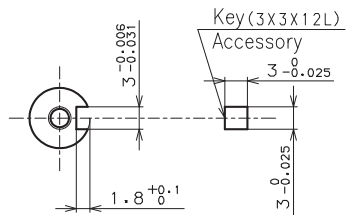

A - A (2 : 1)

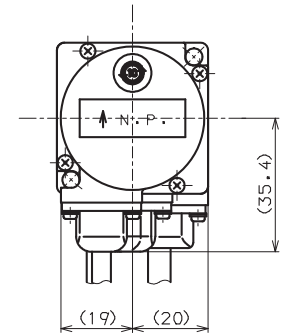
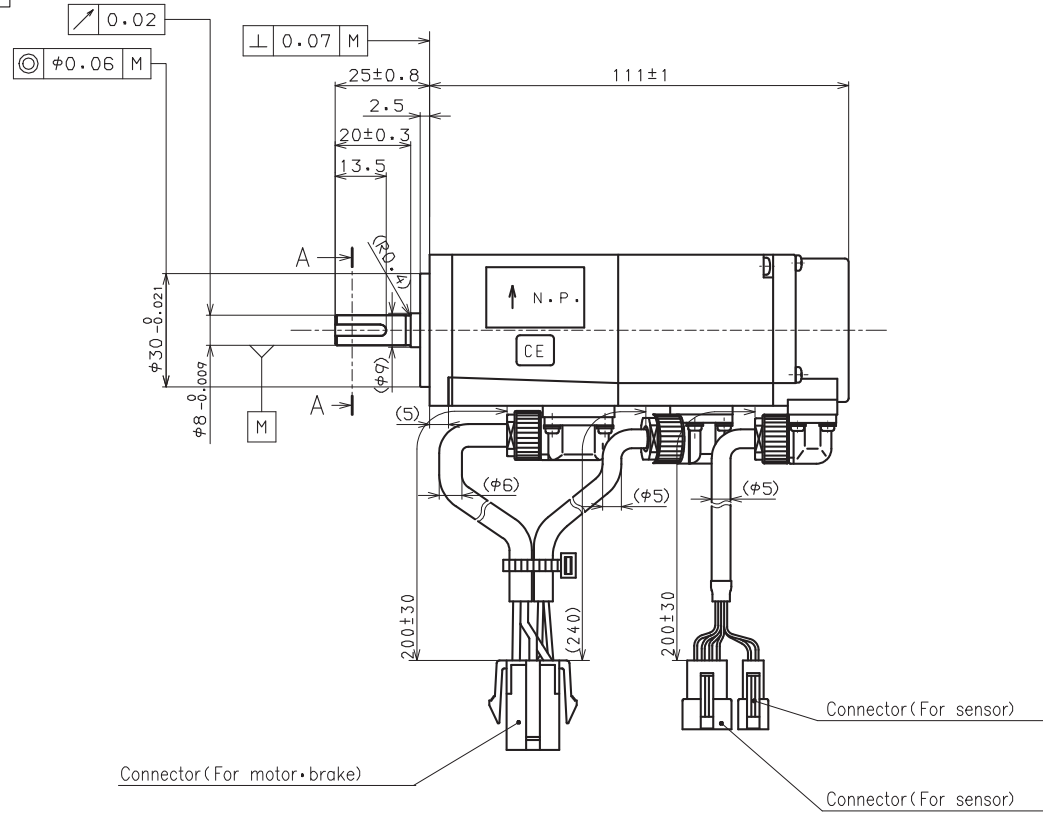
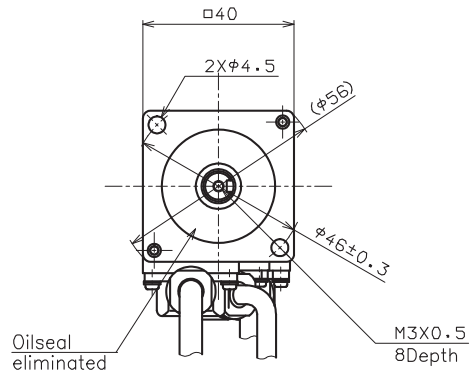