

Model	R2AA06040FXPWJ*
Part No.	410627-127*

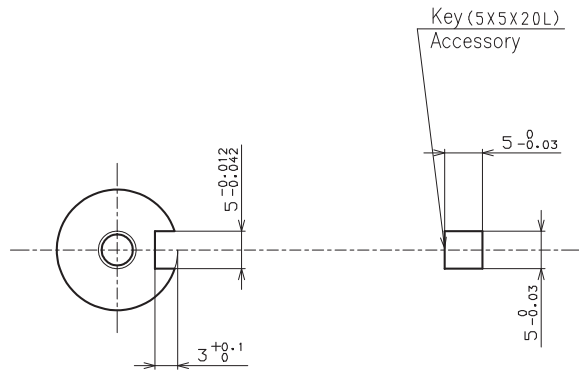

A - A (2 : 1)

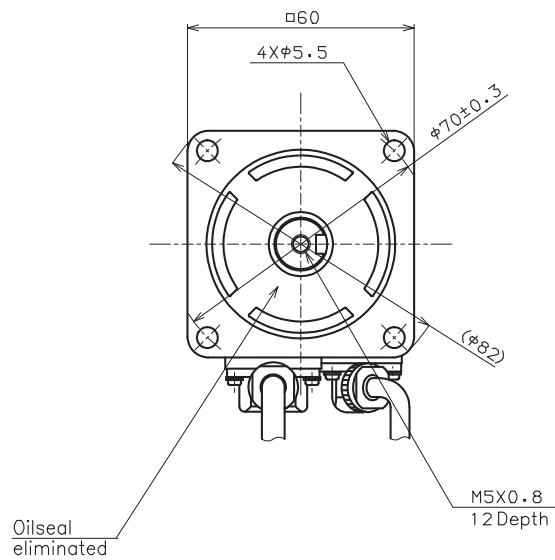