

Model	R2AA08040FCPWJ*
Part No.	410627-130*

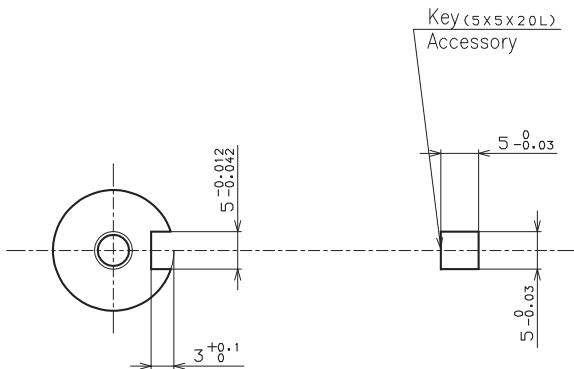

A - A (2 : 1)

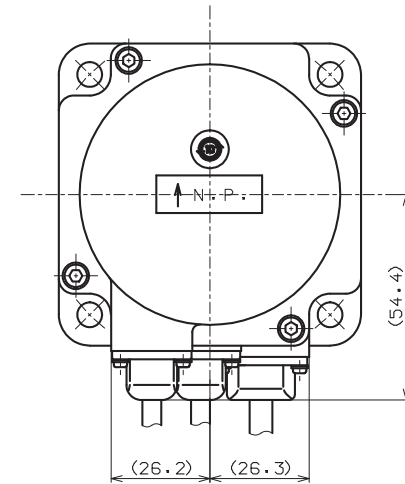
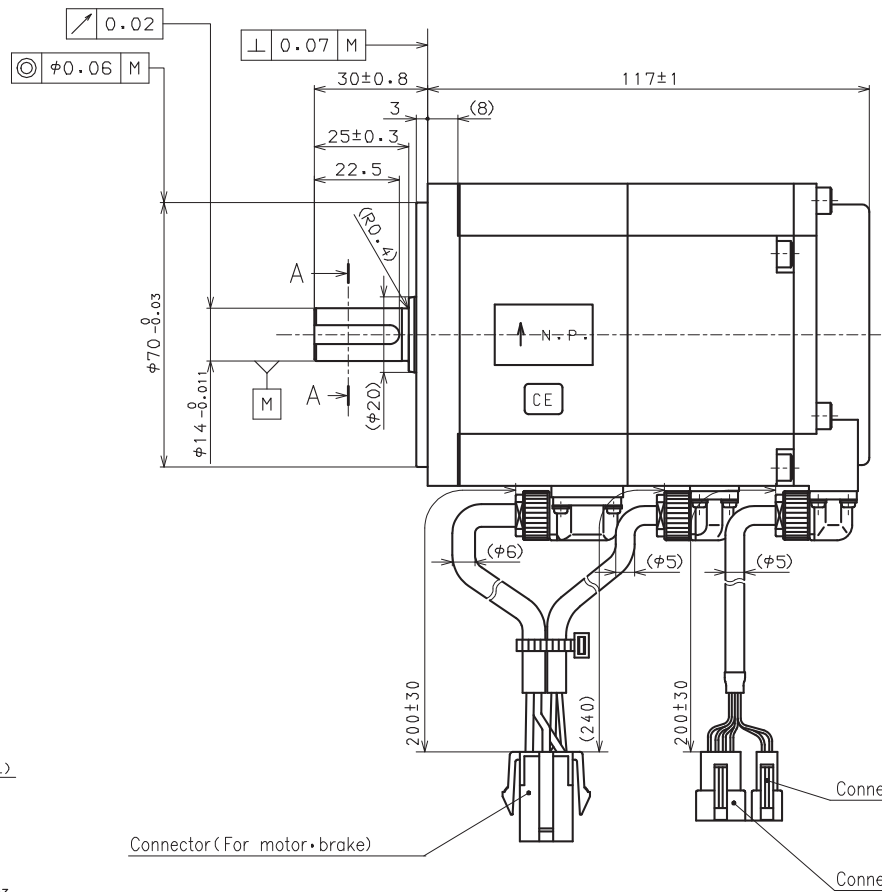
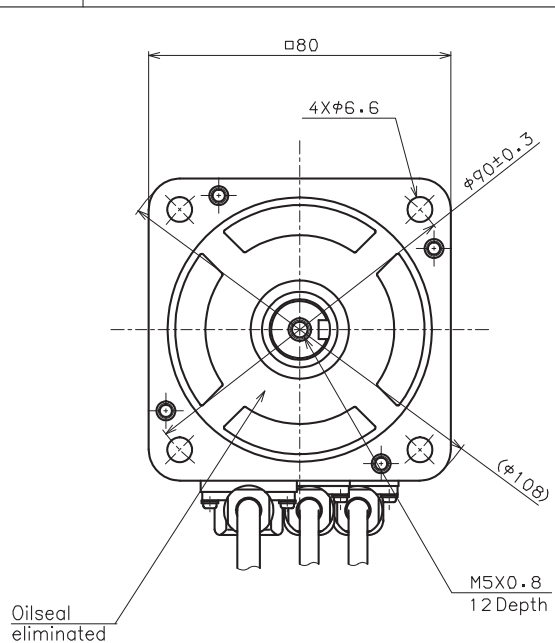