

Model	R2AA04005FXPWM*
Part No.	410627-139*

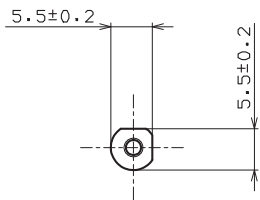

A - A (2 : 1)

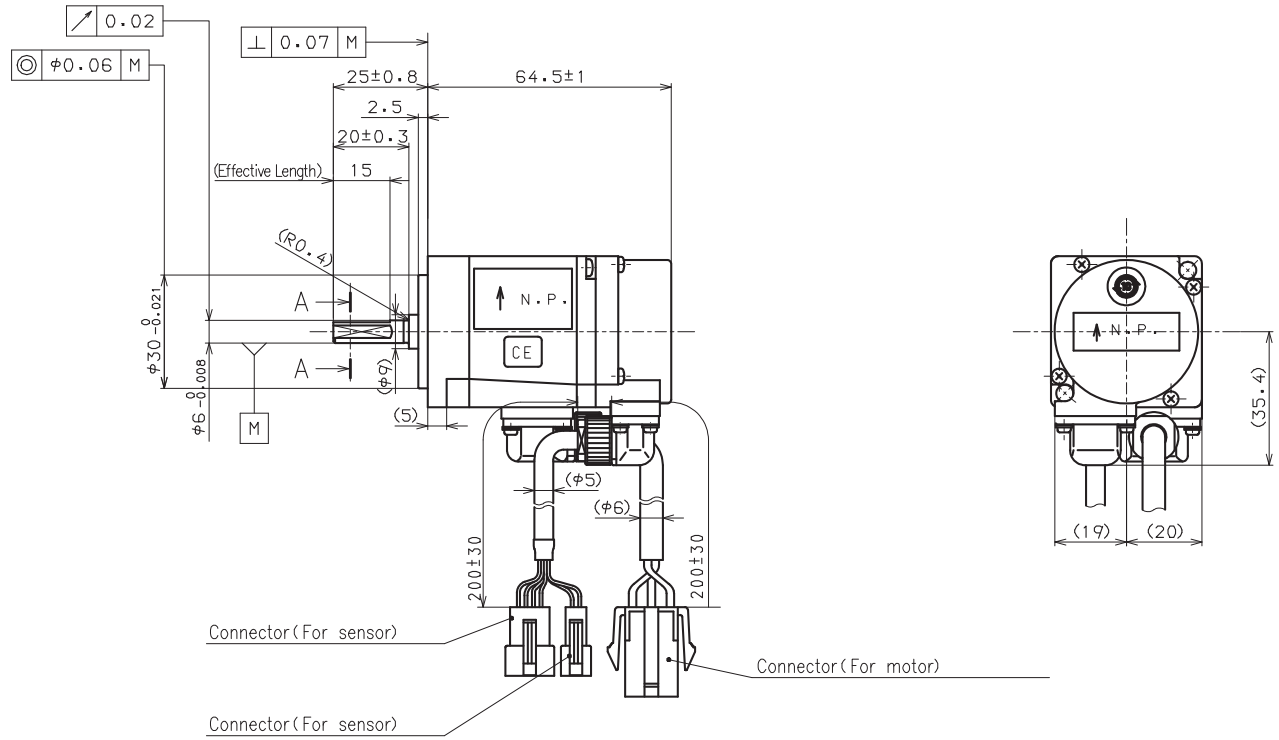
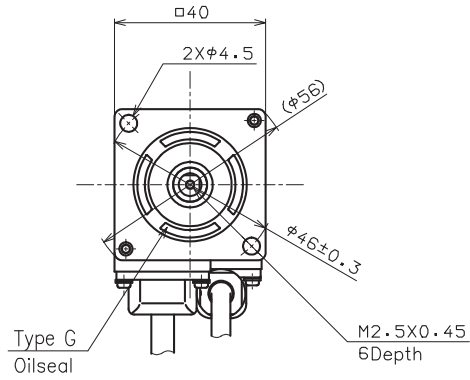