

Model	R2AA06010FXPWK*
Part No.	410627-143*

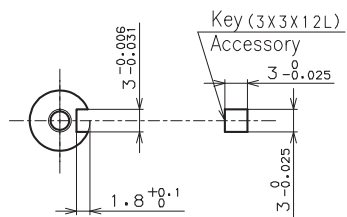

A - A (2 : 1)

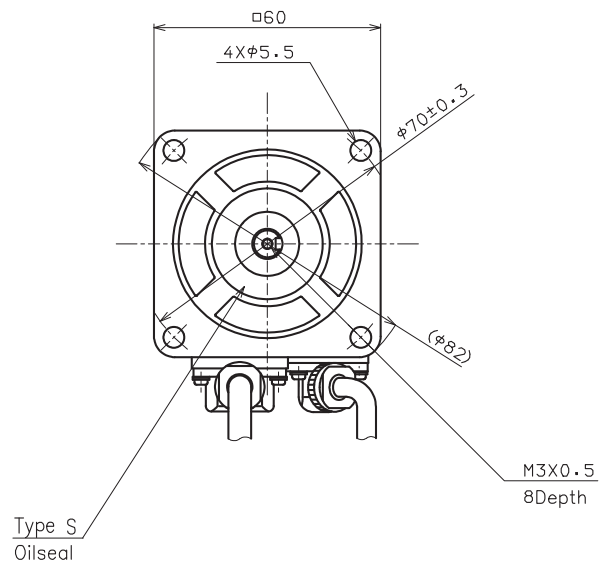