

Model	R2AA08040FCPWK*
Part No.	410627-150*

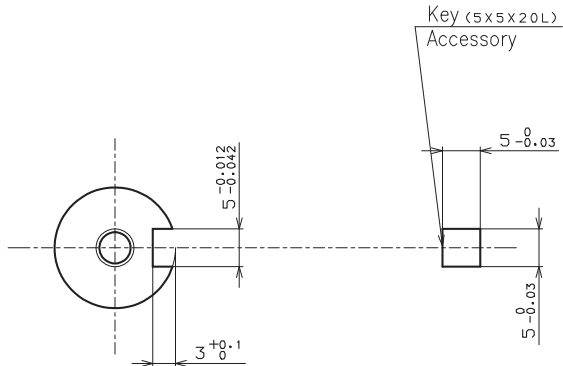

A - A (2 : 1)

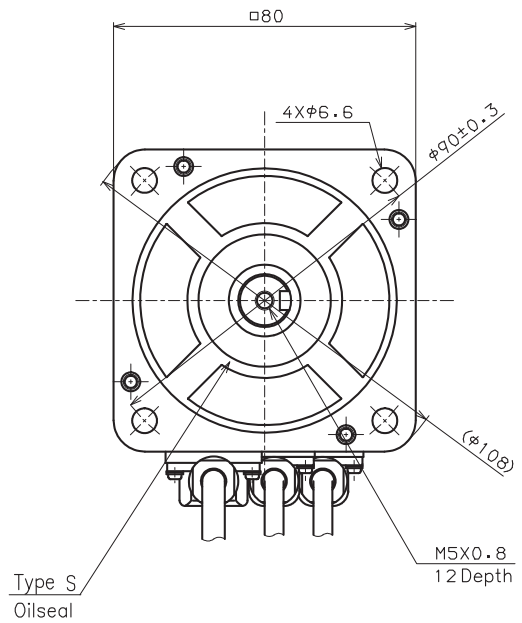